

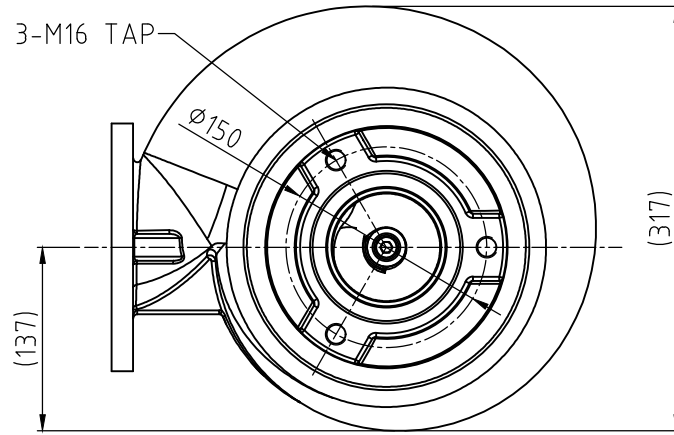

NOTE 1) 1.5kW 4P (80-80) 적용
 2) 윤활유: TUNBINE OIL / ISO VG32 - 500ml

No.	PART NAME	MATERIAL	Q't'y	SIZE	REMARK
01					
02					

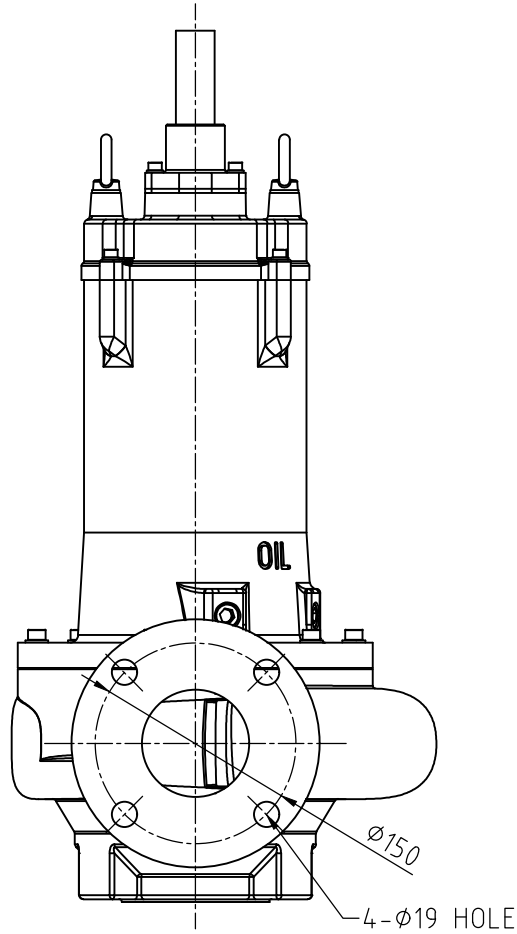
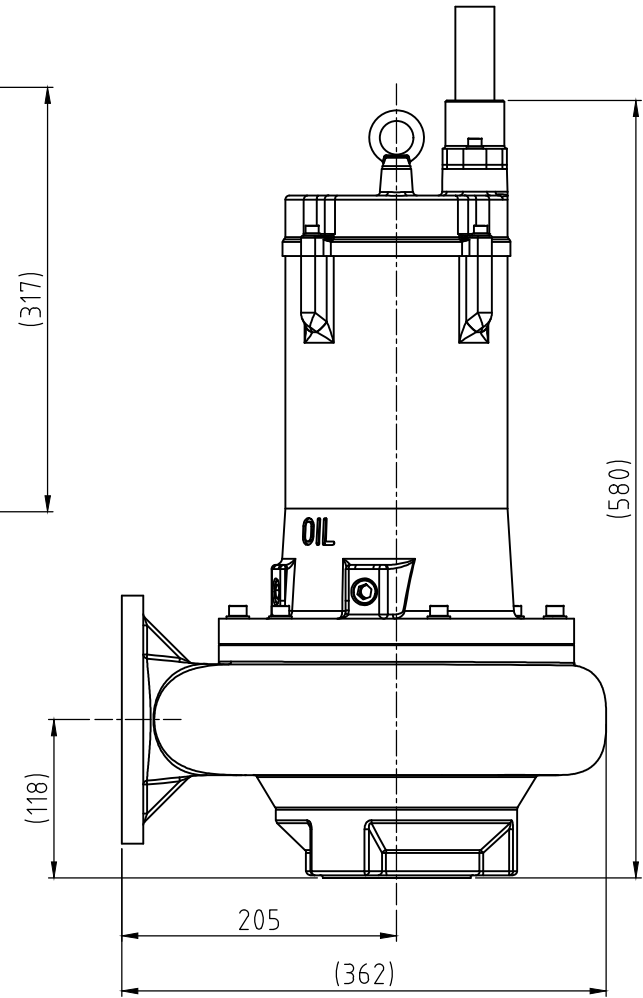

VIEW 'A'



형식 TYPE	고효율 저진동 단일채널 수중펌프			도명 TITLE	외형도 (Outline Drawing)	
DRAWN	DESIGN	CHECKED	APPROVED	3RD ANGLE	SCALE:1/NS	UNIT:mm
H.S.Noh					HWP80-1.5 4P	
20.02.14					SIZE (80-80)	
 黃海電機 HWANG HAE ELECTRIC				도번 DWG. No.	POD00019	