

NOTE 1)

No.	PART NAME	MATERIAL	Qt'y	SIZE	REMARK
01					

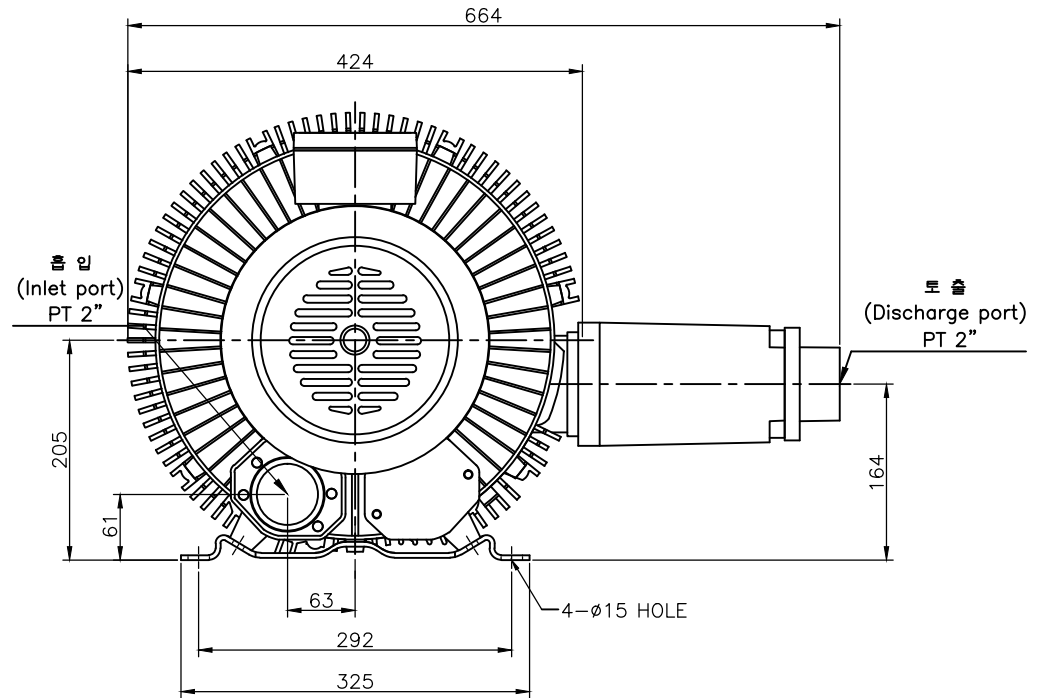
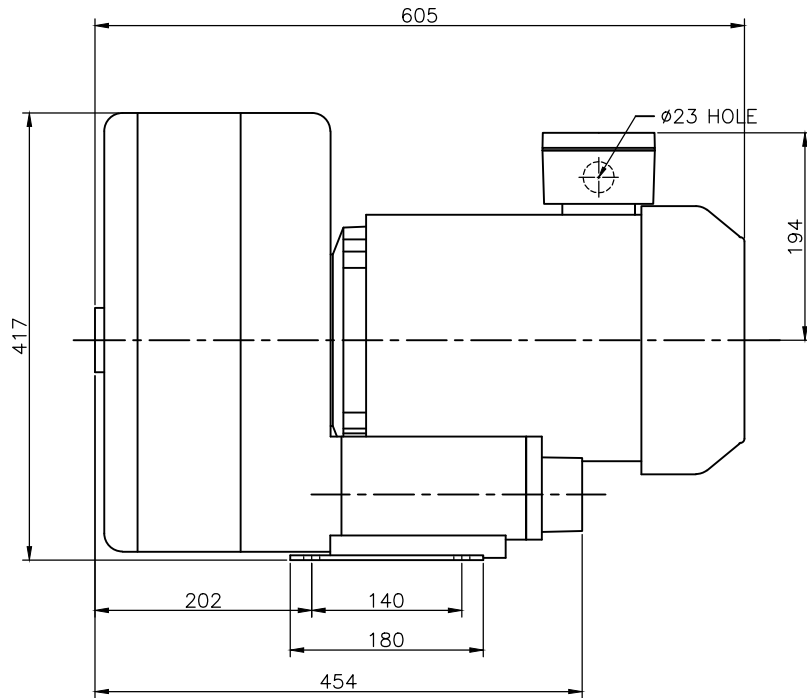

No.	Revision				Date	Draw	Check	Appr.
형식 TYPE	HRB-1002				도명 TITLE	OUTWARD DWG.		
DRAWN	DESIGN	CHECKED	APPROVED	3RD ANGLE	SCALE:1/1	UNIT:mm		
B.S.Kim				SIZE	3Ø 2P 8.6Kw			
13.04.22				도번 DWG. No	BOD00057			△

黃海電機
HWANG HAE ELECTRIC