

NOTE 1)

No.	PART NAME	MATERIAL	Qt'y	SIZE	REMARK
01					

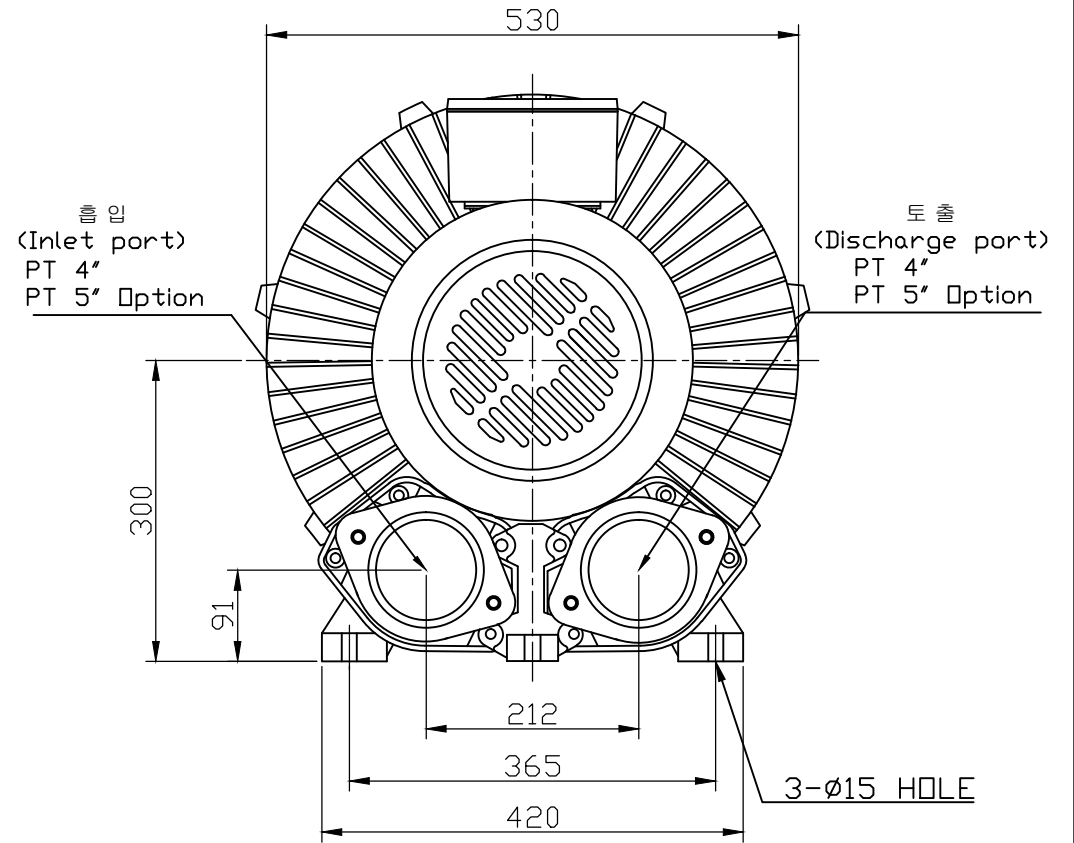
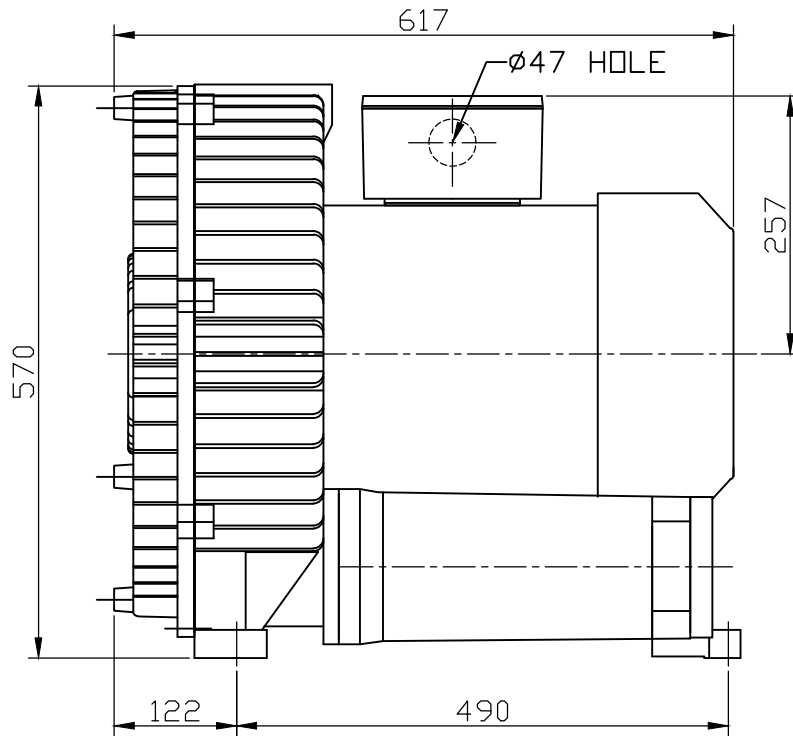

△		00							
No.	Revision			Date	Draw	Check	Appr.		
형식 TYPE	HRB-1200		도명 TITLE	OUTWARD DWG.					
DRAWN	DESIGN	CHECKED	APPROVED	3RD ANGLE	SCALE:1/1	UNIT:mm			
B.S.Kim				SIZE	3Ø 2P 15.3Kw				
13.04.22									
黃海電機 HWANG HAE ELECTRIC				도번 DWG. No	BOD00125		△		