

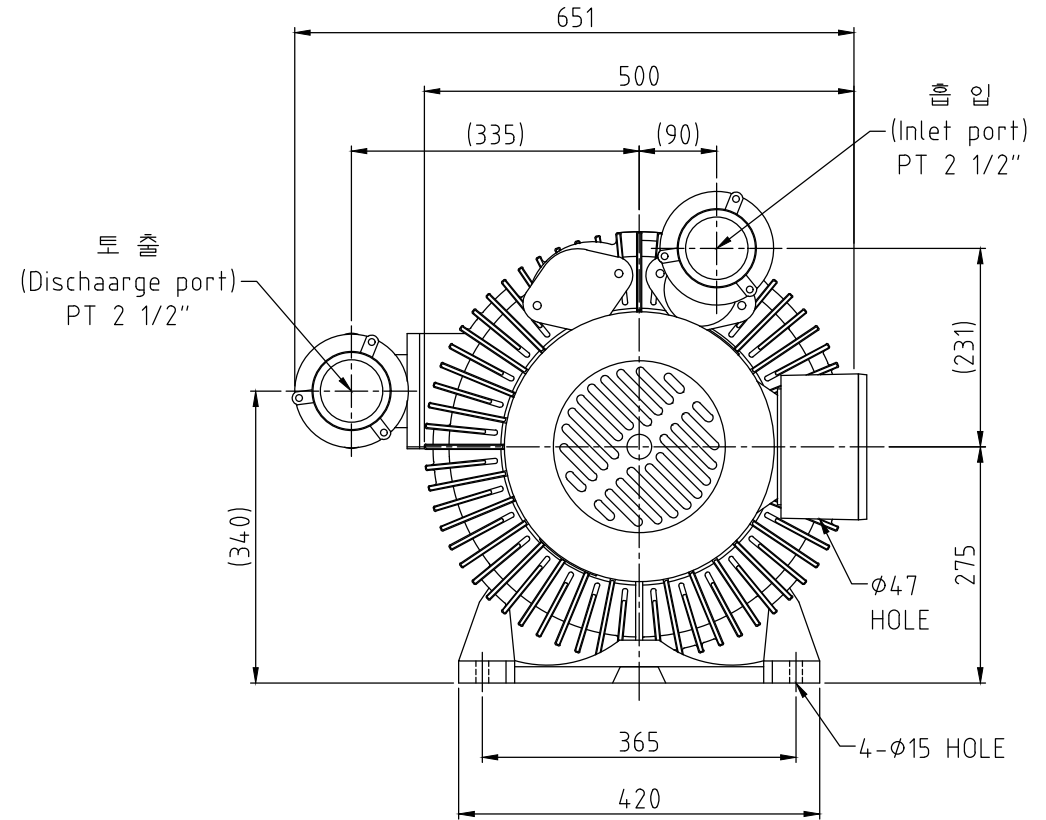

NOTE 1) 참고 치수 (괄호 표기) 의 경우, 제품 개선 등으로 변경될 수 있으니 주의 요망

No.	PART NAME	MATERIAL	Q'ty	SIZE	REMARK
01					
02					

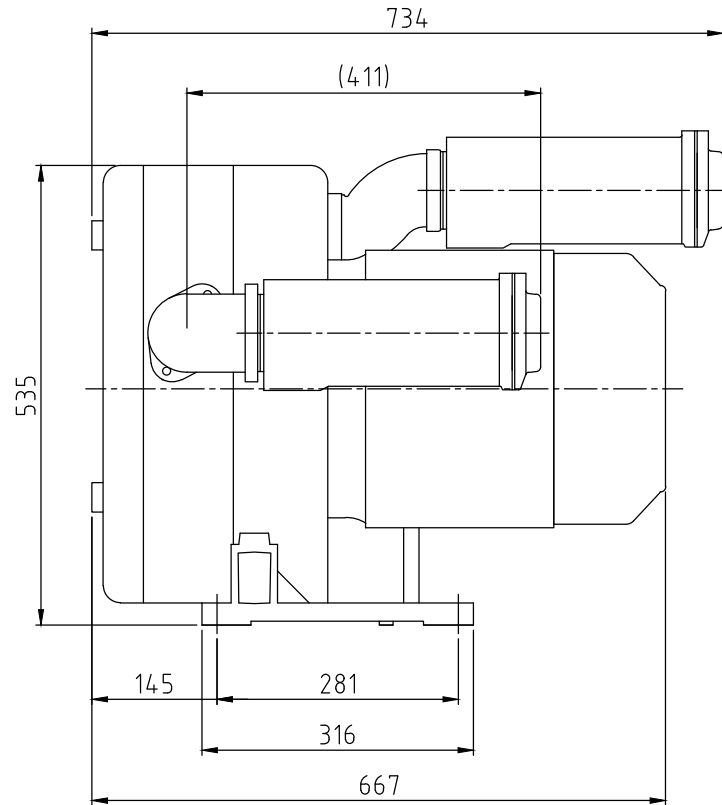

No.	Revision				Date	Draw	Check	Appr.
형식 TYPE	HRB-1202				도명 TITLE	외형도 (Outline DWG.)		
DRAWN	DESIGN	CHECKED	APPROVED	3RD ANGLE	SCALE:1/NS	UNIT:mm		
H.S.Noh				SIZE	3φ 2P 17.3Kw			
22.06.03								
 黃海電機 HWANG HAE ELECTRIC				도번 DWG. No.	BOD00076		