

NOTE 1)

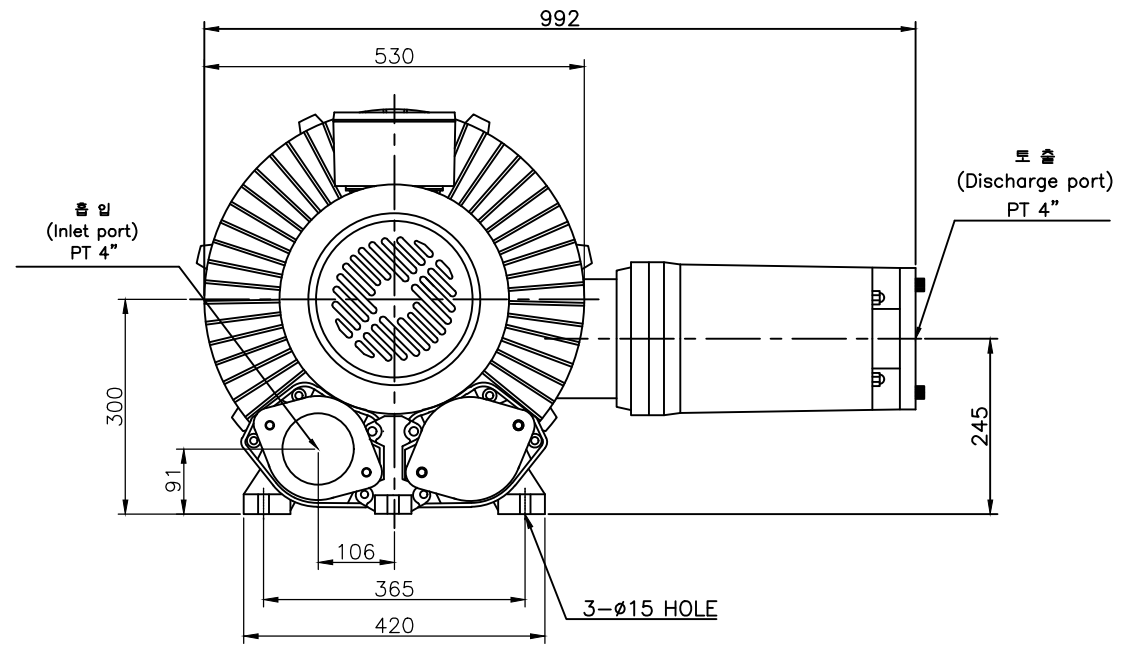
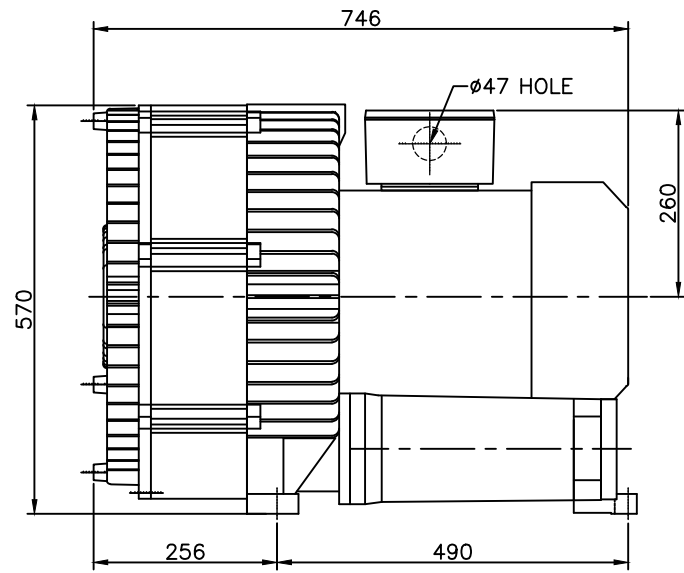

△						00			
No.	Revision					Date	Draw	Check	Appr.
형식 TYPE	HRB-1302			도명 TITLE	OUTWARD DWG.				
DRAWN	DESIGN	CHECKED	APPROVED	3RD ANGLE	SCALE:1/1	UNIT:mm			
B.S.Kim				SIZE	3ø 2P 15.5Kw				
17.03.09									
黃海電機 HWANG HAE ELECTRIC				도번 DWG. No	BOD00148		△		