

NOTE 1)

No.	PART NAME	MATERIAL	Qt'y	SIZE	REMARK
01					

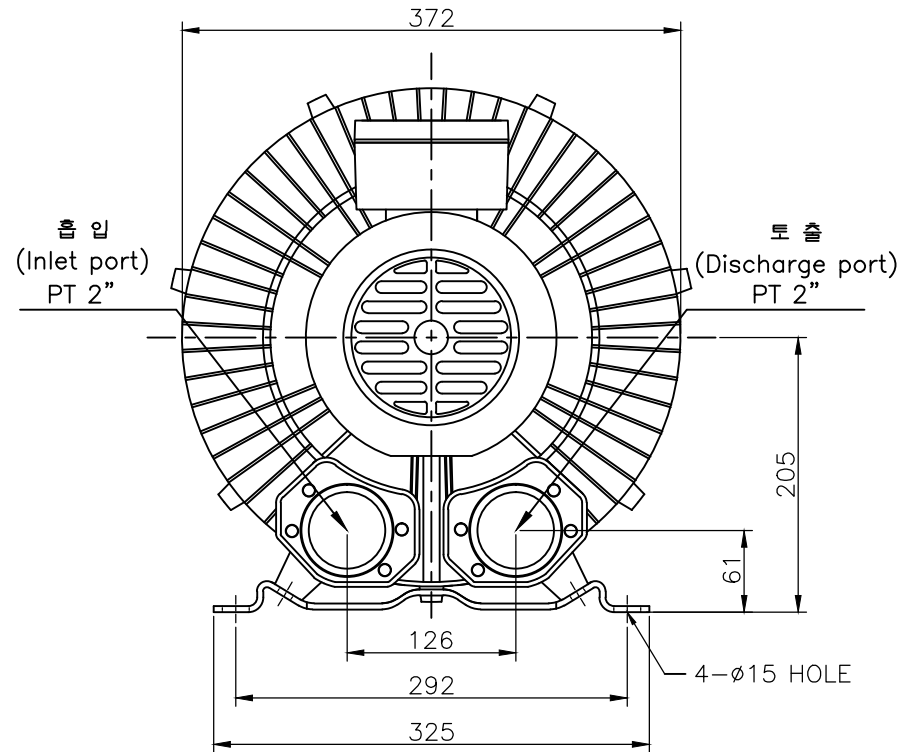
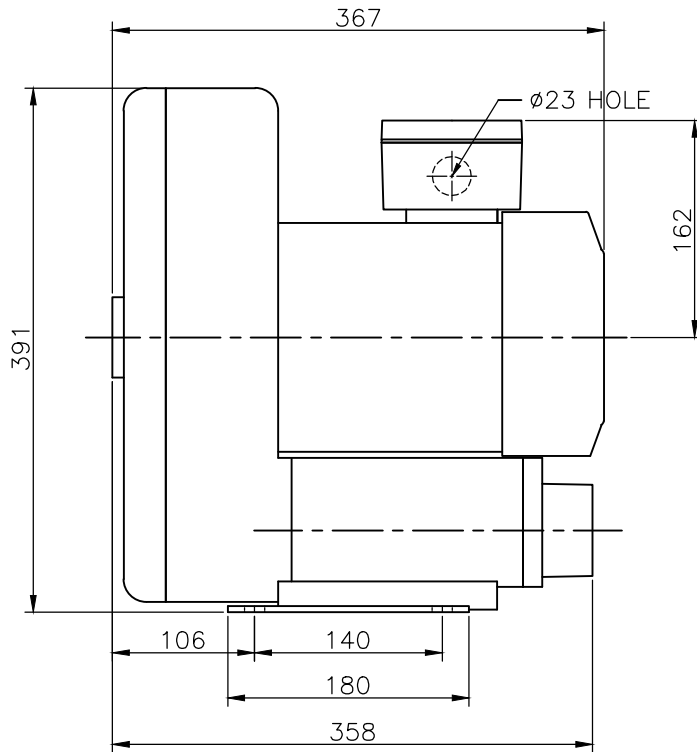

△					00					
No.	Revision				Date	Draw	Check	Appr.		
형식 TYPE	HRB-500		도명 TITLE	OUTWARD DWG.						
DRAWN	DESIGN	CHECKED	APPROVED	3RD ANGLE	SCALE:1/1	UNIT:mm				
B.S.Kim				SIZE	3Ø 2P 2.55Kw					
13.04.22				도번 DWG. No	BOD00082		△			
黃海電機 HWANG HAE ELECTRIC										