

NOTE 1)

No.	PART NAME	MATERIAL	Qt'y	SIZE	REMARK
01					

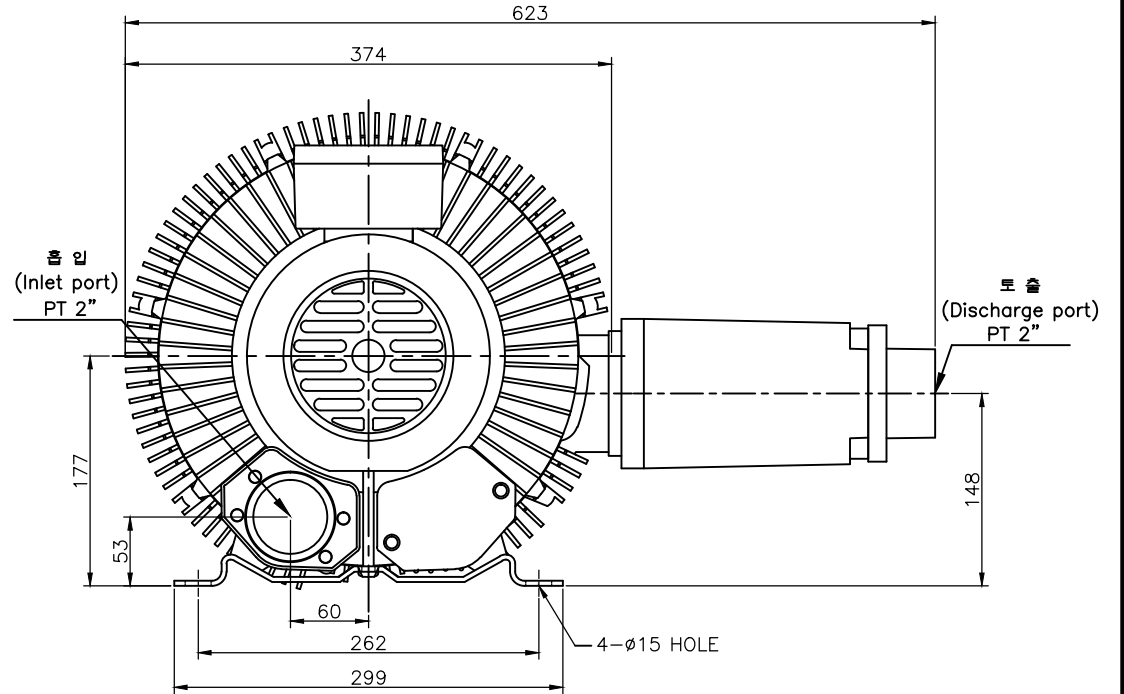
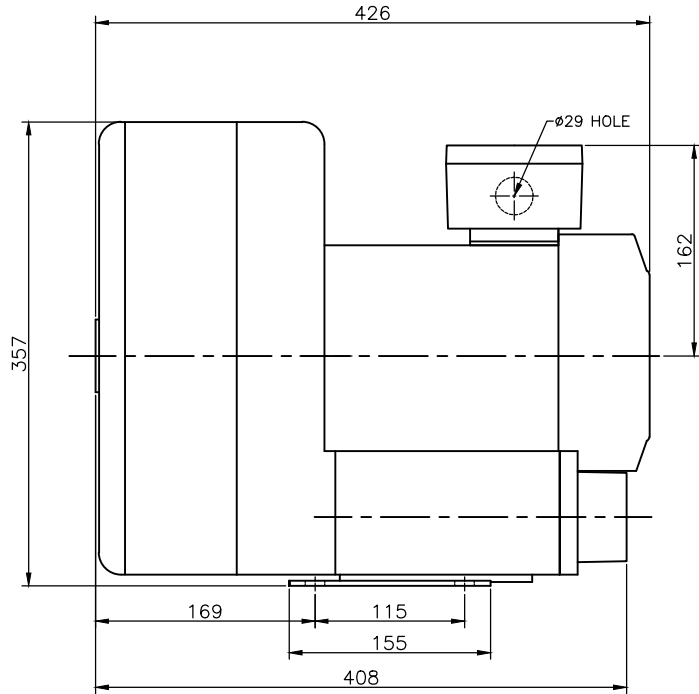

△						00			
No.	Revision					Date	Draw	Check	Appr.
형식 TYPE	HRB-502		도명 TITLE	OUTWARD DWG.					
DRAWN	DESIGN	CHECKED	APPROVED	3RD ANGLE	SCALE:1/1	UNIT:mm			
B.S.Kim				SIZE	3Ø 2P 2.55Kw				
13.04.22									
黃海電機 HWANG HAE ELECTRIC				도번 DWG. No	BOD00137		△		