

NOTE 1)

No.	PART NAME	MATERIAL	Qt'y	SIZE	REMARK
01					

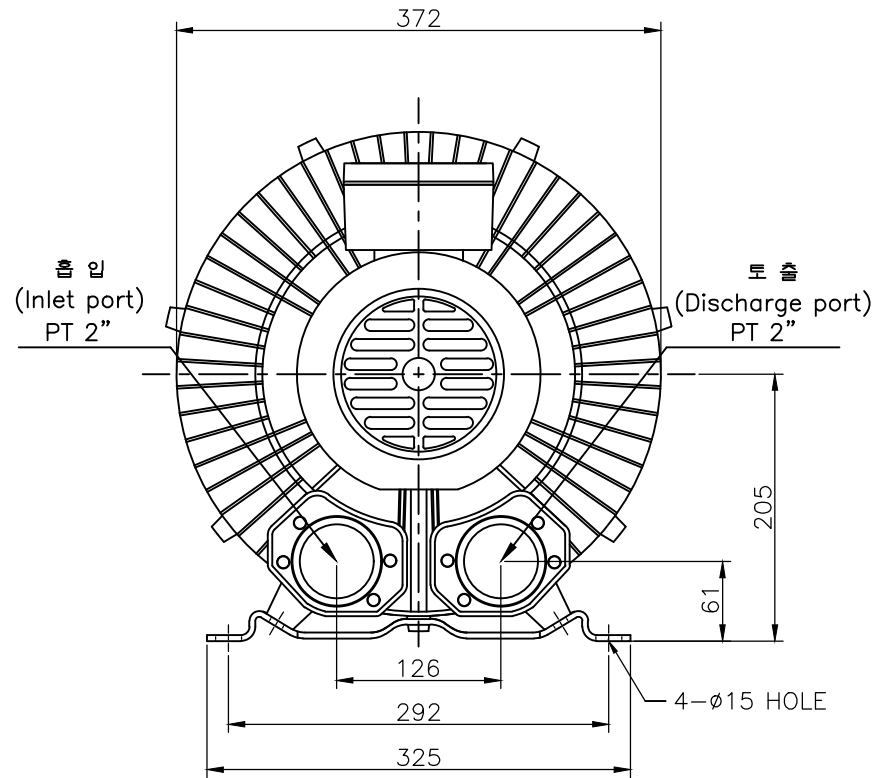
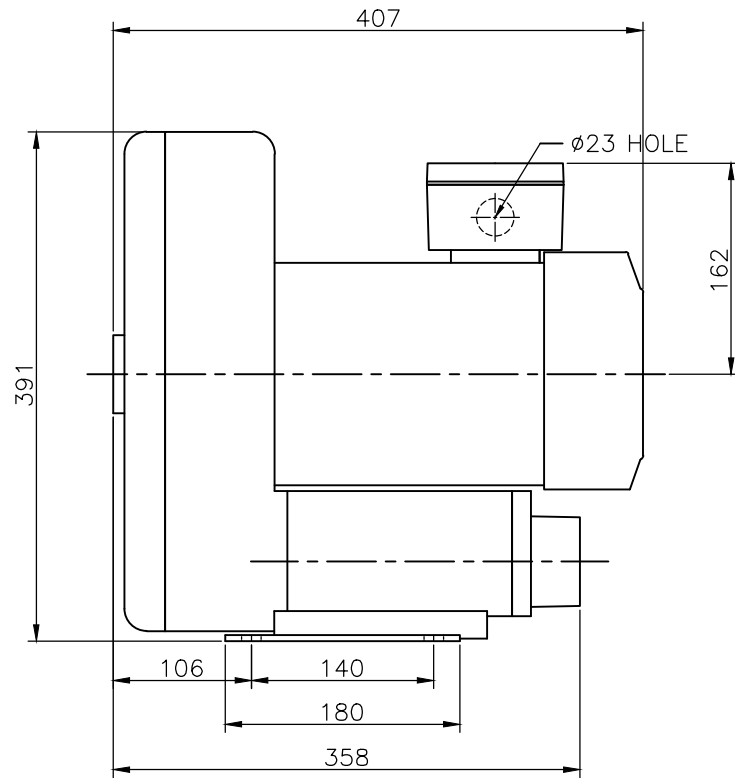

△					00					
No.	Revision				Date	Draw	Check	Appr.		
형식 TYPE	HRB-600MP				도명 TITLE	OUTWARD DWG.				
DRAWN	DESIGN	CHECKED	APPROVED	3RD ANGLE	SCALE:1/1	UNIT:mm				
B.S.Kim				SIZE	3ø 2P 3.7Kw					
13.04.22										
黃海電機 HWANG HAE ELECTRIC				도번 DWG. No.	BOD00166			△		