

NOTE 1)

No.	PART NAME	MATERIAL	Qt'y	SIZE	REMARK
01					

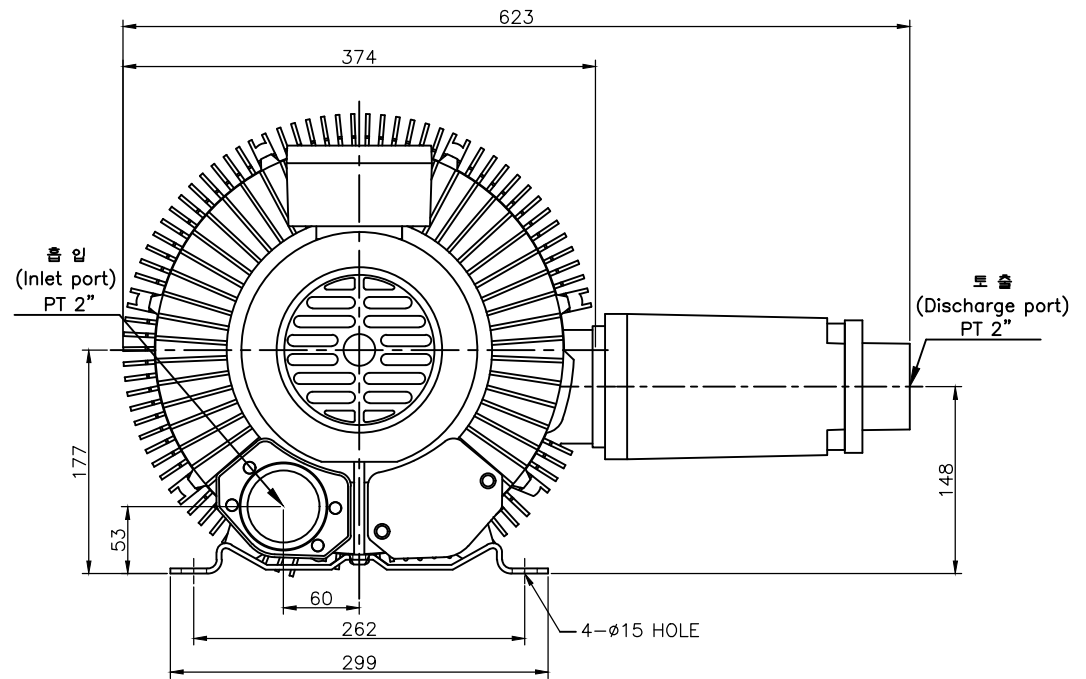
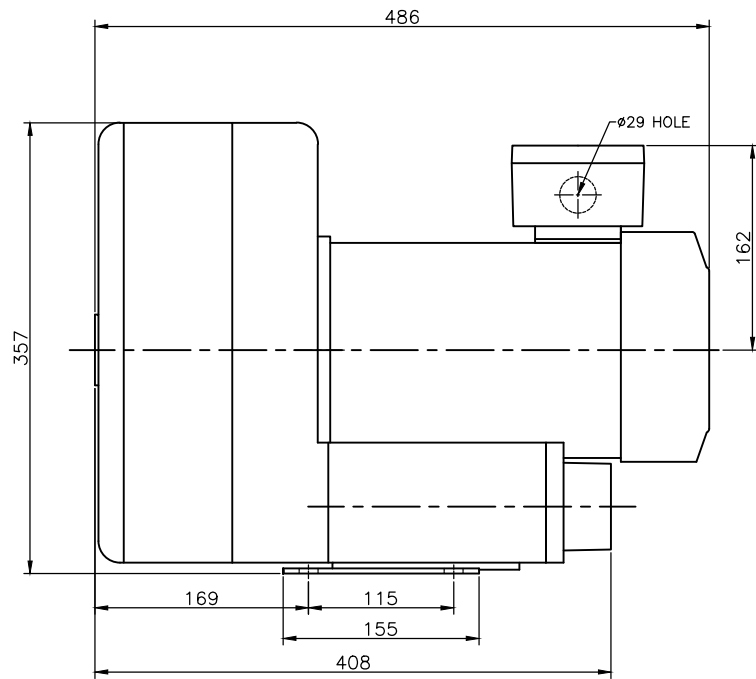

△						00					
No.	Revision					Date	Draw	Check	Appr.		
형식 TYPE	HRB-702MP				도명 TITLE	OUTWARD DWG.					
DRAWN	DESIGN	CHECKED	APPROVED	3RD ANGLE	SCALE:1/1	UNIT:mm					
B.S.Kim					SIZE	3φ 2P 4.5Kw					
13.04.22											
黃海電機 HWANG HAE ELECTRIC						도번 DWG. No.	BOD00168		△		