

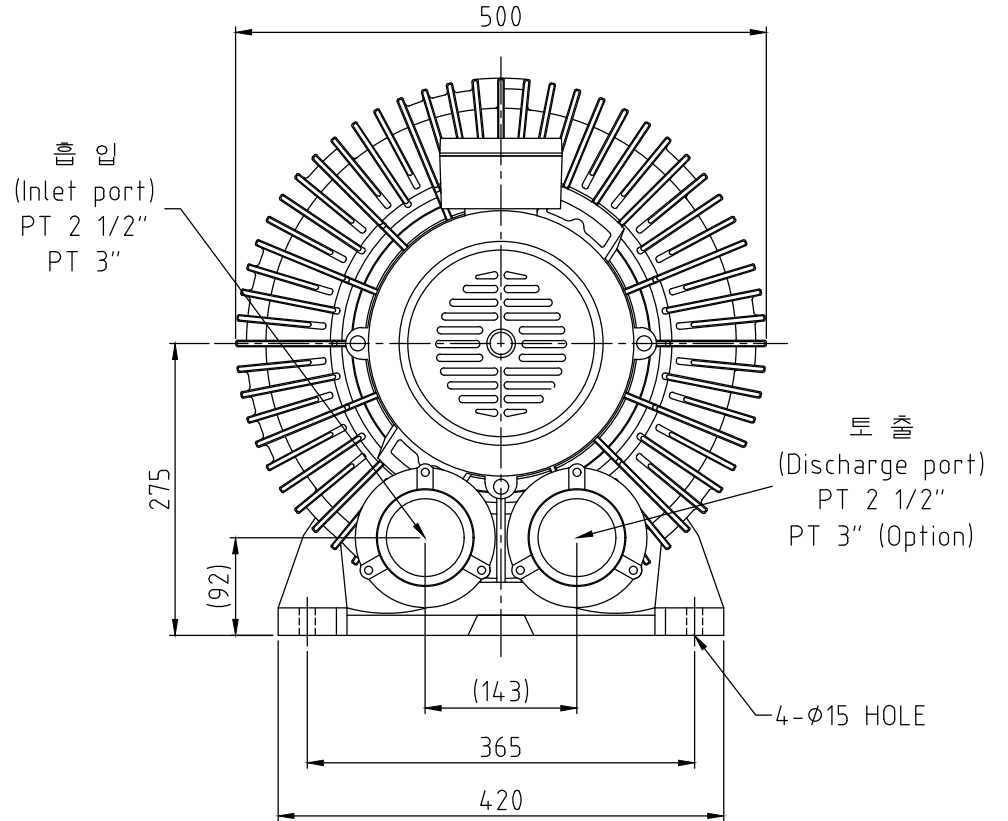

NOTE 1) 참고 치수 (괄호 표기) 의 경우, 제품 개선 등으로 변경될 수 있으니 주의 요망

No.	PART NAME	MATERIAL	Q't'y	SIZE	REMARK
01					
02					

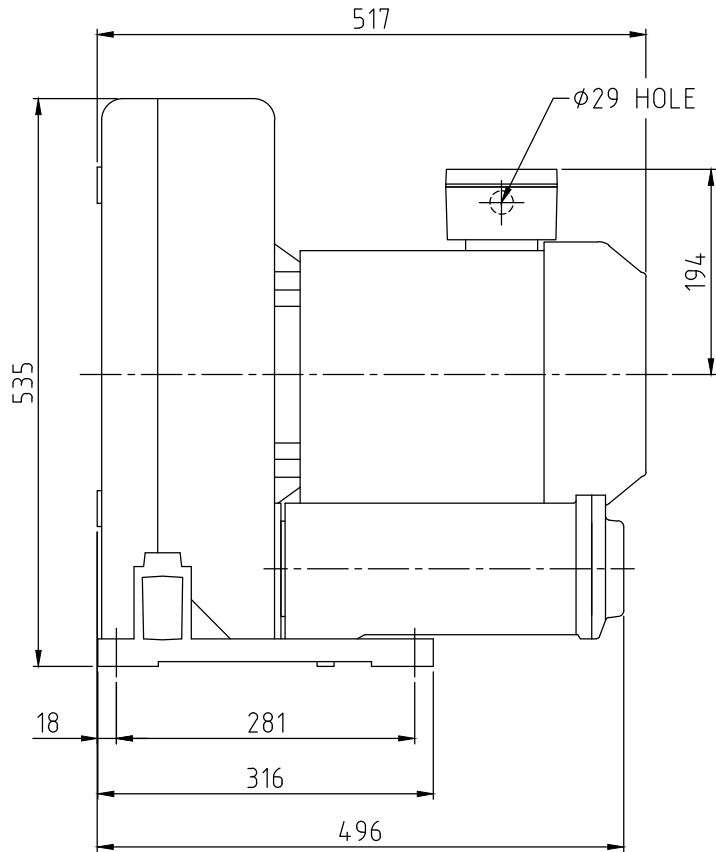

△									
△									
No.	Revision				Date	Draw	Check	Appr.	
형식 TYPE	HRB-800				도명 TITLE	외형도 (Outline DWG.)			
DRAWN	DESIGN	CHECKED	APPROVED	3RD ANGLE	SCALE:1/NS	UNIT:mm			
H.S.Noh				SIZE	3Ø 2P 6.3Kw				
22.06.02									
 黃海電機 HWANG HAE ELECTRIC					도번 DWG. No.	BOD00123			△