

NOTE 1) 2Vane 1.5kW 4P (70-80) 적용
 2) 윤활유: TUNBINE OIL / ISO VG32 - 500ml

No.	PART NAME	MATERIAL	Q't'y	SIZE	REMARK
01					
02					

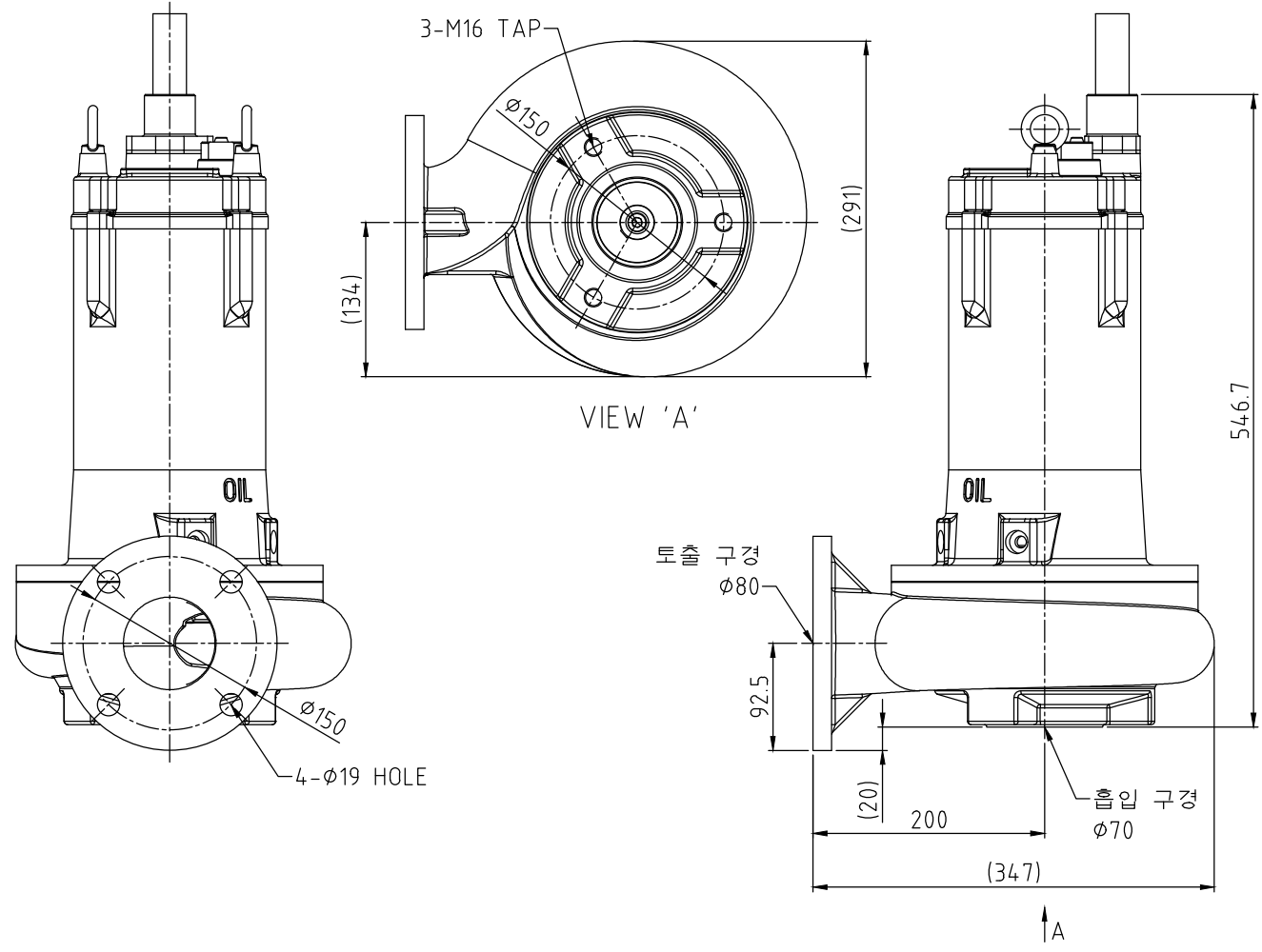

형식 TYPE	2Vane 수증펌프			도명 TITLE	외형도 (Outline Drawing)	
DRAWN	DESIGN	CHECKED	APPROVED	3RD ANGLE	SCALE:1/NS	UNIT:mm
H.S.Noh				SIZE	HWT80-1.5 4P (70-80)	
21.04.22				도번 DWG. No.	POD00037	
黃海電機 HWANG HAE ELECTRIC						